

SURFACE MOUNT LED WHITE, 2014 PACKAGE, 0.5W

BIVAR

SME2014UWDX05

- ◆ Industry Standard 2014 Package
- ◆ RoHS Compliant
- ◆ Small Package and Footprint
- ◆ X - (C) Cool White, (N) Neutral White, (W) Warm White
- ◆ Wide Viewing Angle
- ◆ Ideal for Lighting and Backlighting Application

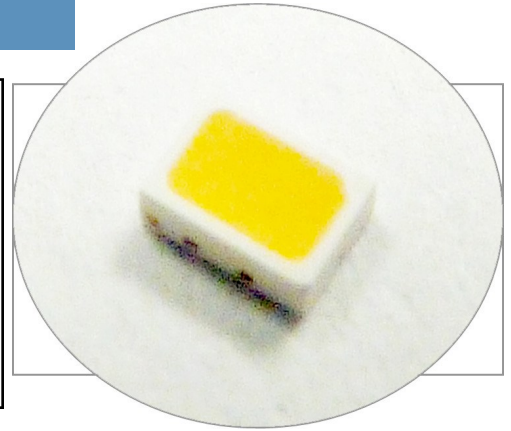

Bivar Surface Mount 2014 package LED may be used in nearly any lighting or backlighting application. The SME2014 Series is made with a special Epoxy Molding Compound that provides excellent heat resistance and is available in 3 color temperatures to meet any illumination needs: Cool, Neutral and Warm White. These 0.5 Watt SMD LED's have a minimum CRI Value of 80 and are conveniently packaged in standard tape and reels for pick and place assemblies.

Part Number	Material	Emitted Color	Lens Color	Luminous Flux (lm) TYP.	Viewing Angle
SME2014UWDC05	InGaN	Cool White	Diffused	52	110°
SME2014UWDN05	InGaN	Neutral White	Diffused	52	110°
SME2014UWDW05	InGaN	Warm White	Diffused	48	110°

Outline Dimensions

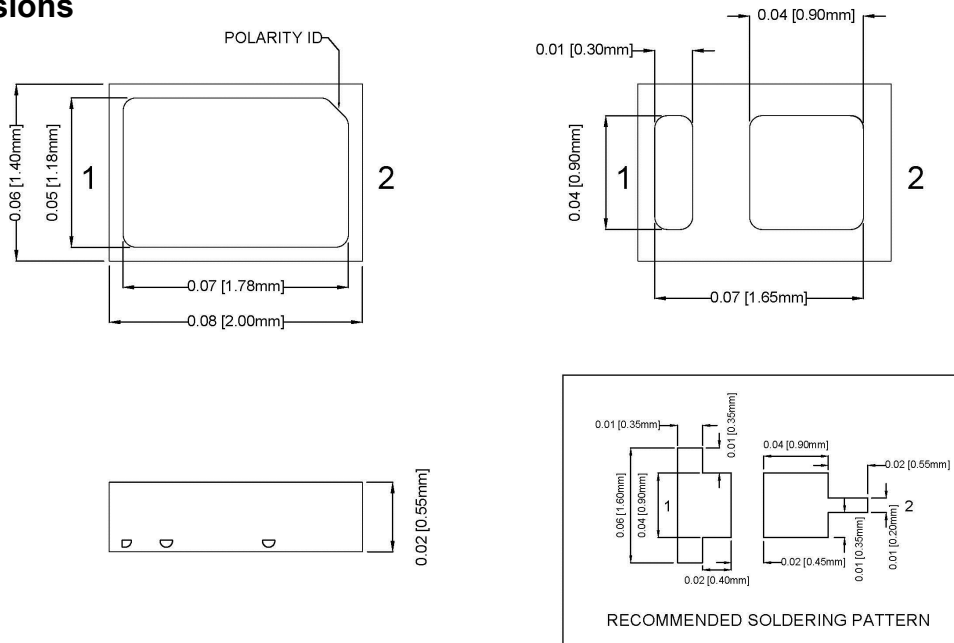

Outline Drawings Notes:

1. All dimensions are in inches [millimeters].
2. Standard tolerance: ± 0.010 unless otherwise noted.



Bivar reserves the right to make changes at any time without notice.

SURFACE MOUNT LED WHITE, 2014 PACKAGE, 0.5W



Absolute Maximum Ratings

$T_A = 25^\circ\text{C}$ unless otherwise noted

Power Dissipation	0.54 W
Forward Current (DC)	150 mA
Peak Forward Current ¹	180 mA
Reverse Voltage	5 V
Electrostatic Discharge (HBM)	1000 V
Operating Temperature Range	-40 ~ +85°C
Storage Temperature Range	-40 ~ +100°C
Junction Temperature	115°C
Lead Soldering Temperature ²	260°C

- Notes: 1. $\leq 10\%$ Duty Cycle, Pulse Width ≤ 0.1 msec.
2. Solder time less than 5 seconds at temperature extreme.

Electrical / Optical Characteristics

$T_A = 25^\circ\text{C}$ & $I_F = 150$ mA unless otherwise noted

Part Number	Forward Voltage (V)			Recommend Forward Current (mA)	Reverse Current (μA) $V_R=5\text{V}$	CCT (Kelvin)			Luminous Flux (lm)			Viewing Angle $2\theta_{1/2}$ (deg)
	MIN	TYP	MAX	TYP	MAX	MIN	TYP	MAX	MIN	TYP	MAX	TYP
SME2014UWDC05	2.8	/	3.6	150	10	5310	5665	6020	45	52	65	110
SME2014UWDN05	2.8	/	3.6	150	10	3710	3985	4260	45	52	65	110
SME2014UWDW05	2.8	/	3.6	150	10	2870	3045	3220	45	48	65	110

- Notes: 1. The above forward voltage measurement allowance tolerance is $\pm 0.1\text{V}$.
2. The above luminous flux measurement allowance tolerance $\pm 10\%$.

Bivar reserves the right to make changes at any time without notice.

SURFACE MOUNT LED WHITE, 2014 PACKAGE, 0.5W



Typical Electrical / Optical Characteristics

$T_A = 25^\circ\text{C}$ unless otherwise noted

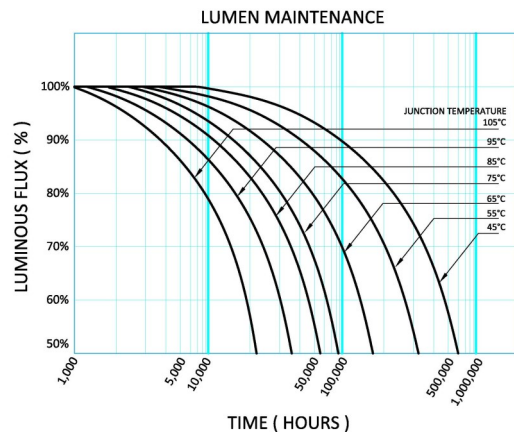
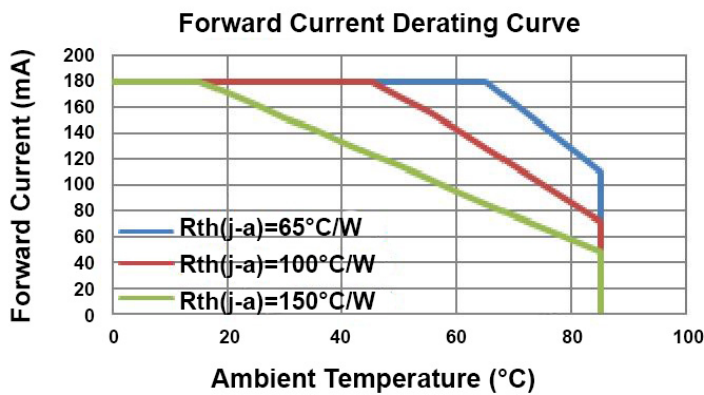
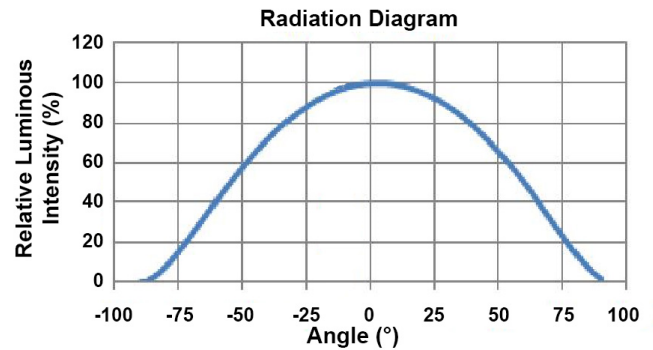
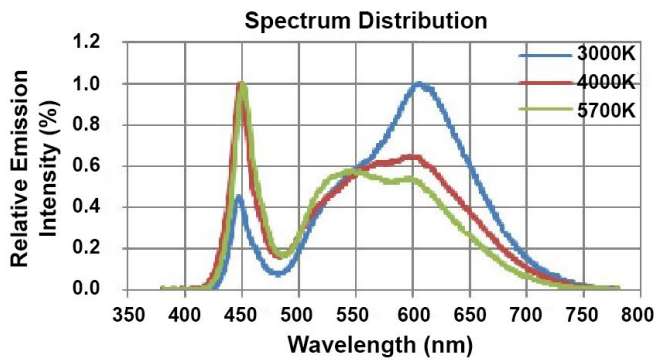
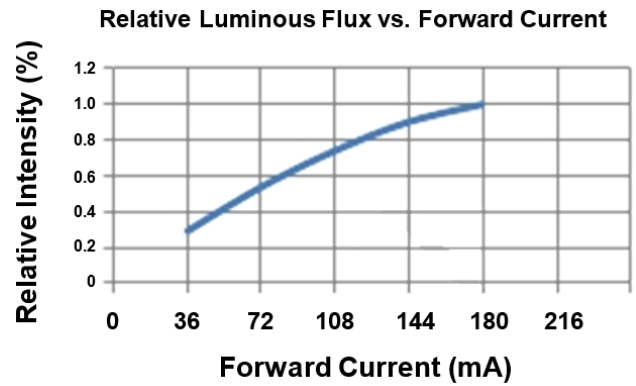
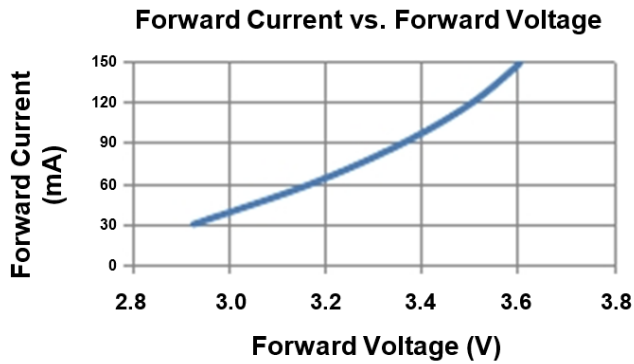

Bivar reserves the right to make changes at any time without notice.

SURFACE MOUNT LED WHITE, 2014 PACKAGE, 0.5W



Recommended Soldering Conditions

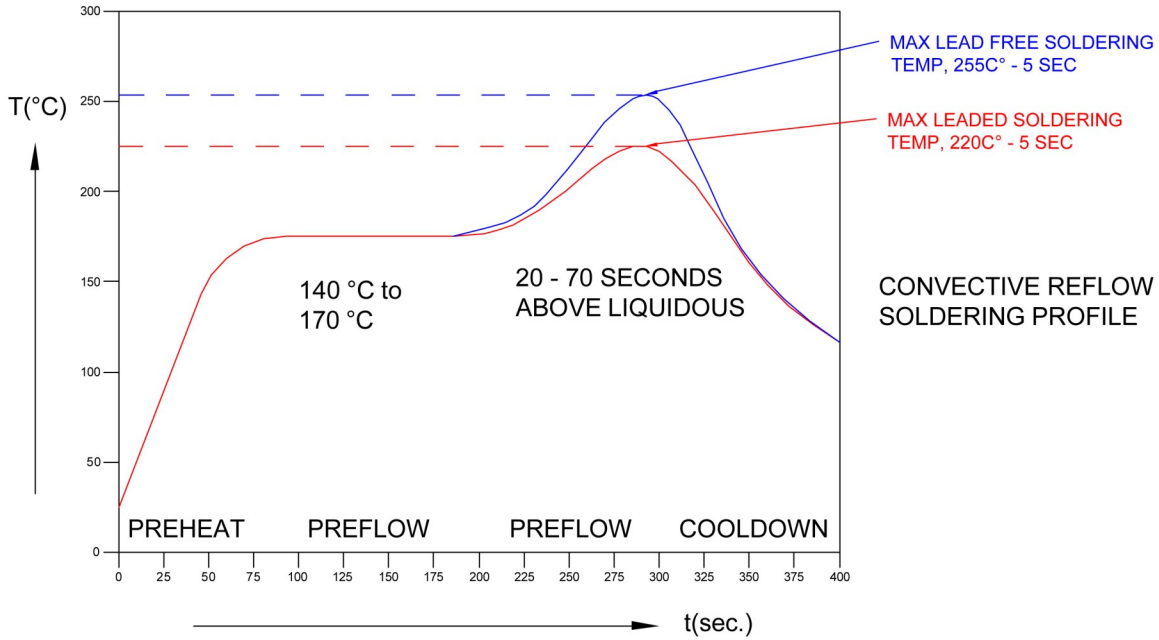

Tape and Reel Dimensions

Note: 5000 pcs/Reel

• Dimensions of Tape

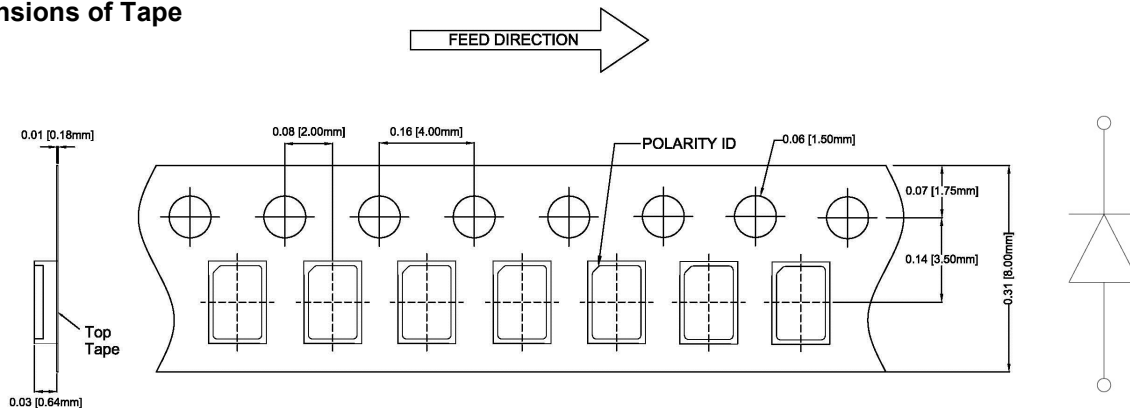

• Arrangement of Tape

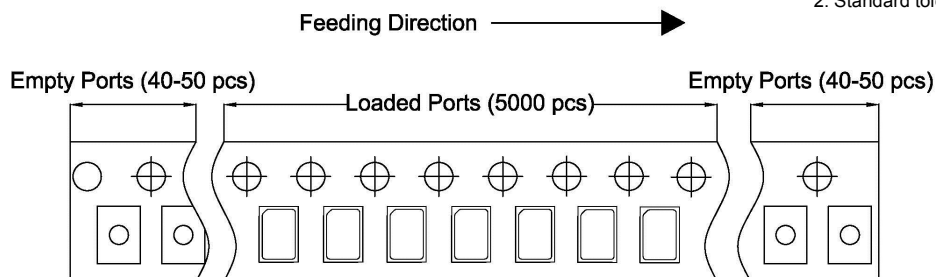

Outline Drawings Notes:

1. All dimensions are in inches [millimeters].
2. Standard tolerance: ± 0.010 " unless otherwise noted.

Bivar reserves the right to make changes at any time without notice.

SURFACE MOUNT LED WHITE, 2014 PACKAGE, 0.5W

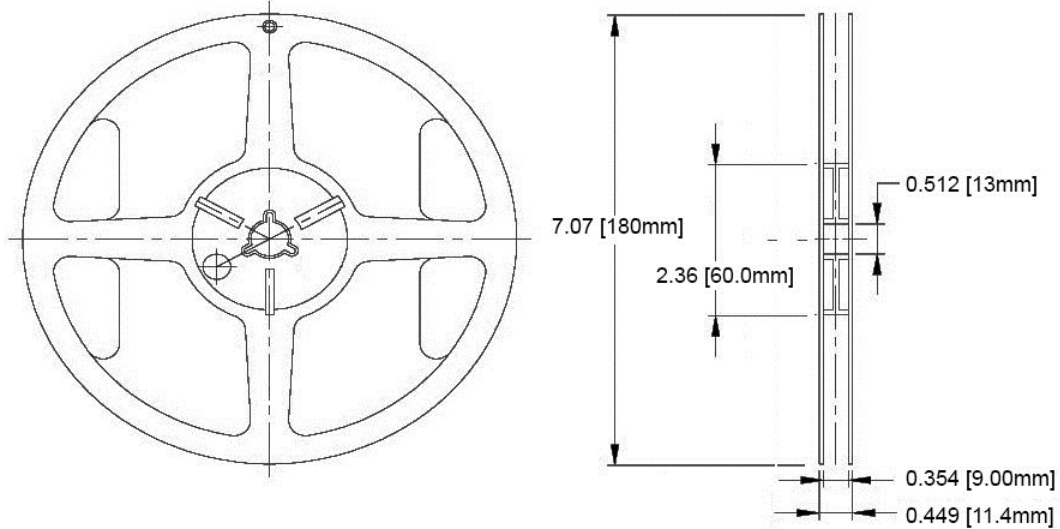

Outline Drawings Notes:
 1. All dimensions are in inches [millimeters].
 2. Standard tolerance unless otherwise noted: X.XXX ± 0.010"
 X.X ± 0.1"

Packaging and Labeling Plan

Note: 1 Reel / Bag

Vacuum and Heat Sealed
ESD/MBB Bag

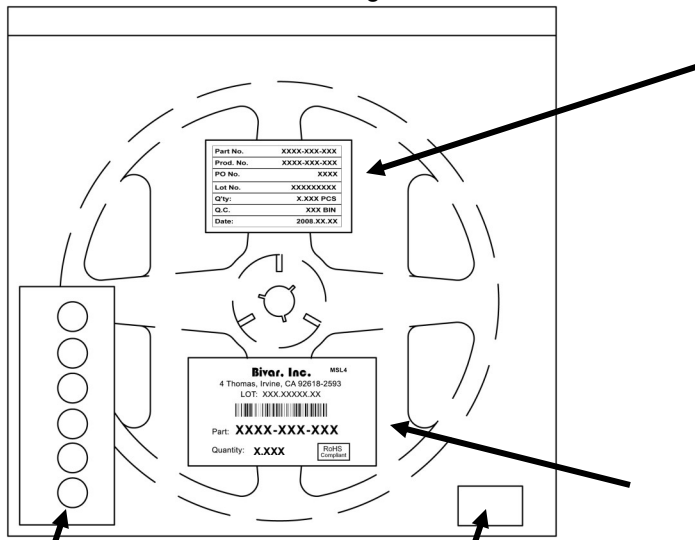

Humidity Indicator Card

Desiccants

Part No.	XXXX-XXX-XXX
Prod. No.	XXXX-XXX-XXX
PO No.	XXXX
Lot No.	XXXXXXXXXX
Q'ty:	X.XXX PCS
Q.C.	XXX BIN
Date:	2008.XX.XX

Internal Quality Control

Bivar, Inc. MSL4

4 Thomas, Irvine, CA 92618-2593
 LOT: XXX.XXXXX.XX



Part: **XXXX-XXX-XXX**

Quantity: **X.XXX**

RoHS
Compliant

Bivar Standard Packaging Label

Bivar reserves the right to make changes at any time without notice.